

C565

Wireless DECT Headset

User guide

Contents

Welcome	3
What's in the box	4
Headset and charger base basics	5
Accessories	6
Customise your headset	7
Right ear loop configuration	7
Left ear loop configuration	7
Position your headset	8
Fitting the headset with headband	9
Charge your headset	10
Connect the power	10
Charge the headset	10
Pair headset to DECT phone	11
Answer and make calls	12
Answer calls	12
Make calls	12
Your headset	13
Headset controls	13
Talk time	13
Battery	13
Muting your headset during a call	14
Adjusting your headset volume	14
Troubleshooting	15

Welcome

Welcome

Congratulations on purchasing your new Plantronics product. This guide contains instructions for setting up and using your C565 Wireless DECT Headset.

Please refer to the separate [safety instructions](#) for important product safety information prior to installation or use of the product.

The enclosed DECT wireless product uses restricted wireless radio frequencies which vary by country. Use of this DECT product in unauthorised countries is a violation of law, may disrupt telecommunications networks and devices, and can subject you to fines and penalties by regulatory agencies.

What's in the box

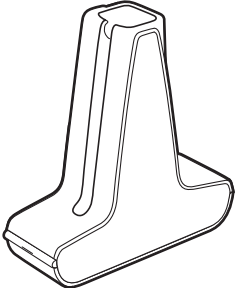

Charger base

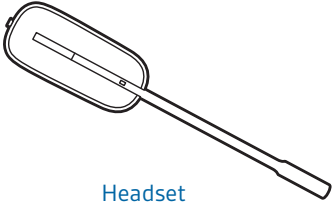

Headset

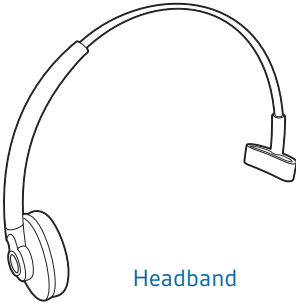

Headband

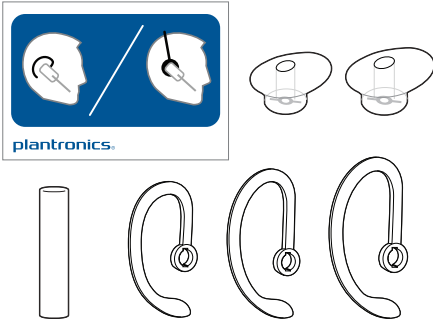

Fit kit instruction card, ear tips, ear loops and ear loop foam

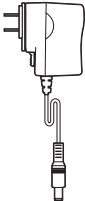

Power supply

Headset and charger base basics

Headset and charger base overview

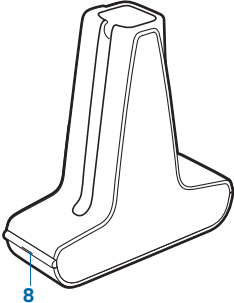
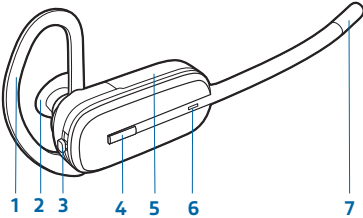

- 1 Ear loop
- 2 Ear tip
- 3 Volume/mute button (press in to mute)
- 4 Call button
- 5 Battery cover
- 6 Indicator light
- 7 Microphone
- 8 Power indicator light

Accessories

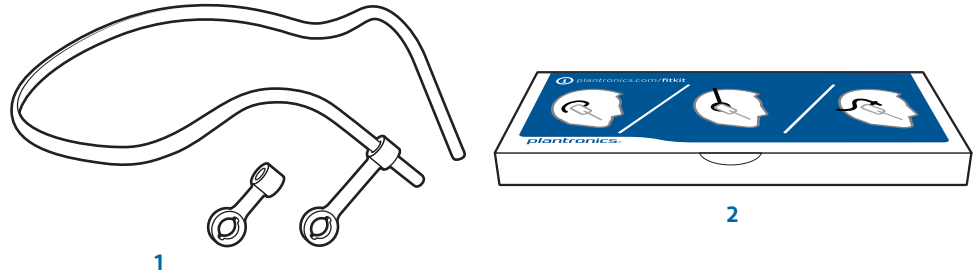

- 1 Behind-the-head headband** Extremely light and comfortable wearing alternative.
- 2 Fit kit with ear loops, ear tips and foam sleeve**

Customise your headset

Your headset can be converted for wearing on the left or right ear with either an ear loop or headband.

Right ear loop configuration

- 1 Choose the size of ear loop that fits most comfortably. Align the ear loop as shown and insert it onto the headset.

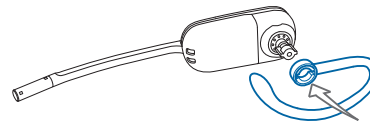

- 2 Rotate the ear loop up 90 degrees.

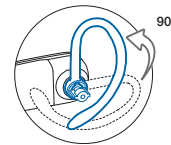

- 3 Choose the size and style of ear tip that fits most comfortably. Align the ear tip with the notch facing the microphone as shown.

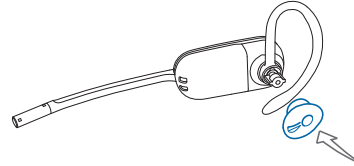

- 4 Press in to attach.



Left ear loop configuration

- 1 Choose the size of ear loop that fits most comfortably. Align the ear loop as shown and insert it onto the headset.

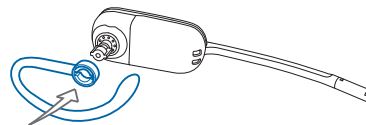

- 2 Rotate the ear loop up 90 degrees.

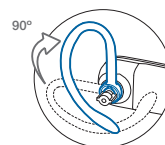

- 3 Choose the size and style of ear tip that fits most comfortably. Align the ear tip with the notch facing the microphone as shown.

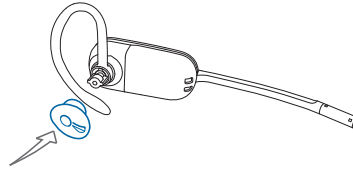

- 4 Press in to attach.

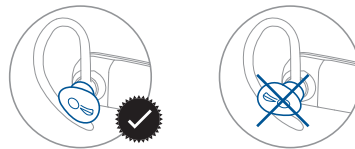

Position your headset

When you wear the headset, the microphone should rest as close to your cheek as possible without touching. The microphone can be adjusted inward by pivoting the earpiece to optimise the position of the headset.

- 1 Slide the headset over and behind your ear and fit the ear tip into your ear.

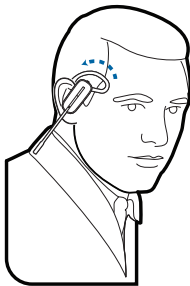

- 2 Holding the base of the headset, push it in and back towards your ear to allow the pivoting earpiece to bring the microphone close to your mouth. As the base of the headset moves backwards, you will feel soft clicks until the microphone rests close to your cheek.

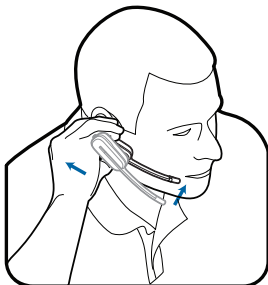

Fitting the headset with headband

The headset can be rotated for wearing on the left or right ear.

- 1 Hold the headband so it is aligned to receive the headset as shown and insert the headset into the headband.

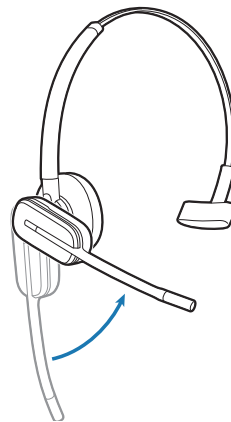
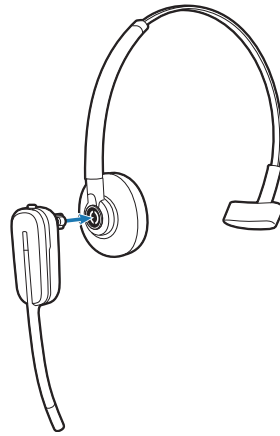

- 2 Rotate the headset up.
- 3 To optimise the position of the headset, push the headset in so the microphone is close to your mouth.

Charge your headset

This section describes how to charge your C565 headset.

Connect the power

Plug one end of the power supply into the power jack on the back of the charger base and the other end into a working power outlet. The power indicator light will be solid white.

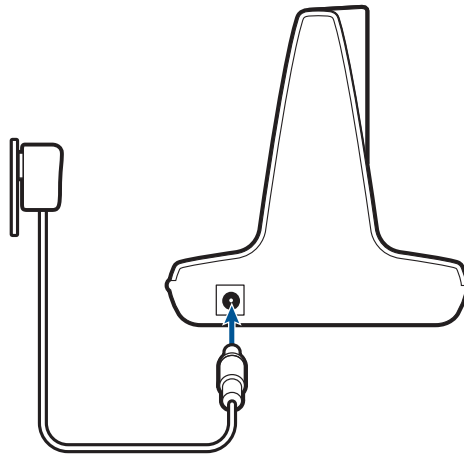

Charge the headset

- 1 Gently push the headset into the charging cradle. The charging indicator light on the headset will flash white to indicate that the headset battery is charging and will turn solid white when fully charged.
- 2 Charge for at least 20 minutes prior to first use. A full charge takes 3 hours.

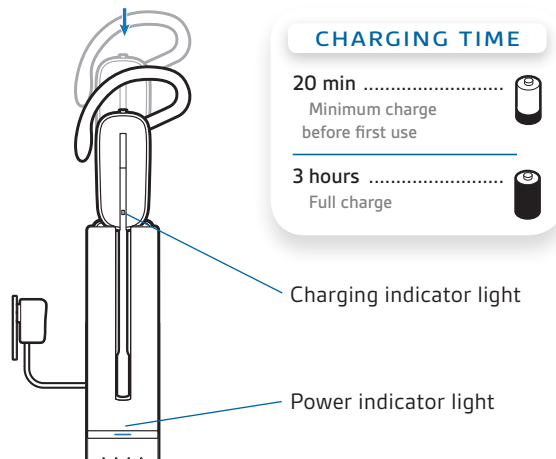

NOTE This product has a replaceable battery. Only use the battery type supplied by Plantronics.

Pair headset to DECT phone

Once your headset is charged, pair your headset to DECT phone.

- 1 Lift the headset out of the charger base, press and hold the volume up button for 3 seconds until the indicator light is solid white.

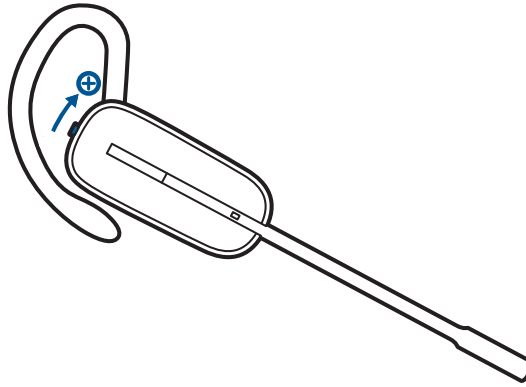

The Headset is now in pairing mode.

- 2 Using the instructions in your phone user guide, place your cordless telephone base into pairing mode. When the indicator light extinguishes, the headset is paired. The phone must be set to the default pin code 0000.

Answer and make calls

This section describes how to answer and make calls with your C565 headset.

Answer calls

The headset will ring for an incoming call. Press the call button as shown to answer.

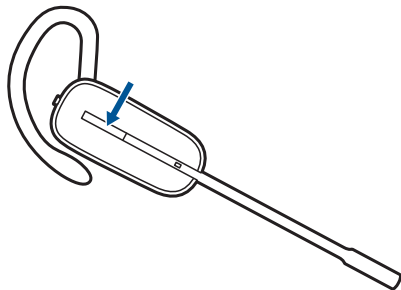

The volume level can be changed by pushing the volume button up to increase the volume and pushing the volume button down to decrease the volume.*

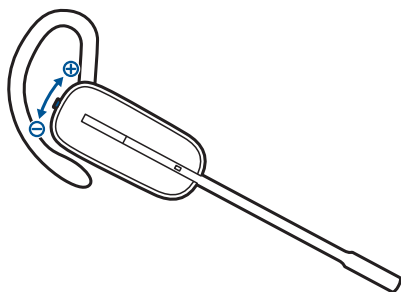

The call can be muted or unmuted by pressing the volume button in.

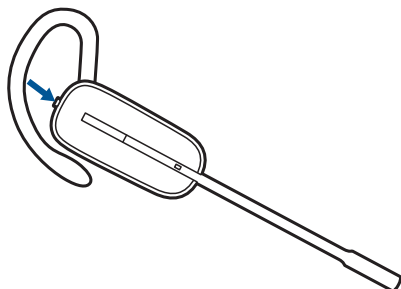

*When headset is worn on right ear. The opposite is true when headset is worn on left ear.

Make calls

Dial a number using a handset. Following the instructions in your phone user guide about transferring calls to other extensions, transfer the call to the C565 headset.

Your headset

Now that you've charged your headset and paired it to your DECT phone, read this section to learn about the headset features and how to use the controls.

Headset controls

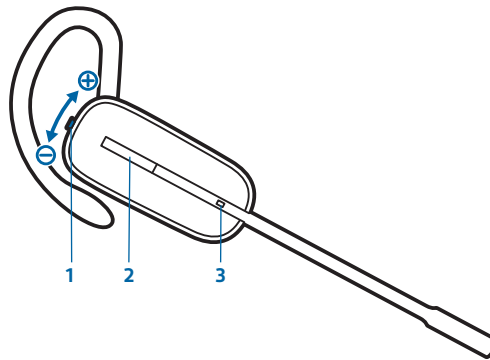

1 Volume/mute button

This table describes the volume controls if you wear the headset on the right. The volume controls are opposite if you wear it on the left.

Increase the volume

Press the volume button up.

Decrease the volume

Press the volume button down.

Mute/unmute a call

To mute/unmute the headset, press the volume/mute button in.

2 Call button

Place, answer, end a call

Briefly press the call button.

3 Headset indicator light

Flashes white when in use.



IMPORTANT For your safety, do not use headset at high volumes for extended periods of time. Doing so can cause hearing loss. Always listen at moderate levels. For more information on headsets and hearing visit: [plantronics.com/healthandsafety](https://www.plantronics.com/healthandsafety).

Talk time

With a single full charge, the C565 will provide up to 7 hours of talk time.

Battery

This product has a replaceable battery. To ensure replacement batteries meet Plantronics high quality standards and for optimal performance, only use replacement batteries provided by Plantronics.

Low battery warning

If you are on a call and the headset battery is critically low, you will hear a repeated single low tone every 15 seconds indicating that the battery is low. You should recharge the headset immediately.

If you are not on a call and press the call button, you will hear three low tones if the battery is critically low. You should recharge the headset immediately.

Battery replacement

If after long use you notice that a fully charged battery is no longer lasting long enough, you can replace it.

- 1 Slide battery cover down and remove from headset.
- 2 With your thumb and index finger, pull the battery out from the attachment clip.
- 3 With your thumb and index finger, grasp the battery connector and disconnect connector and battery from headset.
- 4 Install the new battery by reversing the previous steps.

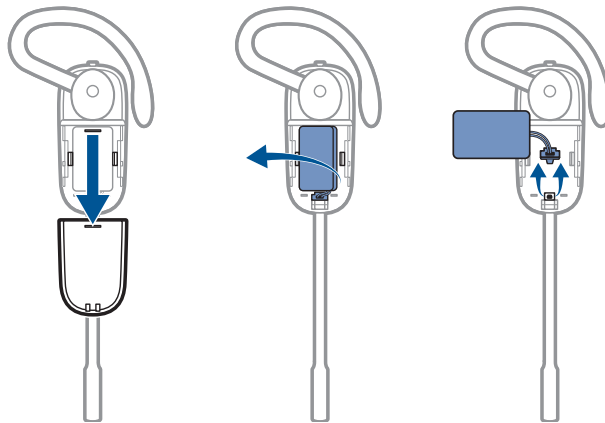

Muting your headset during a call

To mute/unmute the call, press the volume button in.

When mute is activated, you will hear three high tones (you will still be able to hear the caller).

Adjusting your headset volume

Fine-tune your headset volume by pressing the volume/mute button up (increase) or down (decrease) if you wear your headset on the right. If you wear it on the left, it's opposite: press down to increase the volume and up to decrease the volume.

Out of range warning tones

If you are on a call and go out of the operating range, you will hear three low tones. You will hear a single mid tone when you are back in range.

If you stay out of range, an active call will be suspended. The call will be re-established when you walk back into range. If you remain out of range for more than 5 minutes, the headset will drop the call.

If you are not on a call and go out of the operating range and then press the call button, you will hear a single tone for the button press and three low tones for the failure to make a link.

Troubleshooting

My headset is unstable.

When you wear the headset, the microphone should rest as close to your cheek as possible without touching. The microphone can be adjusted inward by pivoting the earpiece to optimise the position of the headset. See [Position your headset](#).

Talk time performance is significantly degraded even after a full recharge.

Battery is wearing out. Call Plantronics at (800) 544-4660 for ordering a replacement battery or contact us at plantronics.com/support.



Congratulations!

The product you have just purchased carries the TCO Certified Headsets 2 label. This means that your headset is designed and manufactured according to some of the strictest performance and environmental criteria in the world. The manufacturer of this headset has selected it to be certified to TCO Certified Headsets 2 as a sign of usability, high performance and reduced impact on the natural environment.

Products certified to TCO Certified Headsets 2 are specifically designed for limiting the risk for hearing impairment. The headsets have acoustic limit protection to protect the user from sudden "sound-spikes" caused by interference on the telephone lines.

Other features of TCO Certified Headsets 2:

Ergonomics

- Volume control, individual adjustment and adaptation, replaceable parts and quality durability.

Energy

- Low energy consumption on the charging station.

Emissions

- Low SAR value. Low electromagnetic fields surrounding the charger.

Ecology

- Product is designed for recycling. Manufacturer must have a certified environmental management system such as EMAS or ISO 14 001
- Restrictions on

- Chlorinated and brominated flame retardants and polymers
- Hazardous heavy metals such as cadmium, mercury, hexavalent chromium and lead.

All TCO labelled products are verified and certified by TCO Development, an independent third-party labelling organisation. For over 20 years, TCO Development has been at the forefront of moving the design of IT equipment in a more user-friendly direction. Our criteria are developed in collaboration with an international group of researchers, experts, users and manufacturers. Since the program's inception, TCO labelled products have grown in popularity and are now requested by users and IT-manufacturers all over the world.

Full specifications and lists of certified products can be found on our homepage – www.tcodevelopment.com

NEED MORE HELP?

plantronics.com/support

Plantronics, Inc.

345 Encinal Street
Santa Cruz, CA 95060
United States

Plantronics BV

South Point Building C
Scorpius 140
2132 LR Hoofddorp
Netherlands

© 2014 Plantronics, Inc. C565 is a trademark of Plantronics, Inc. and Plantronics is a trademark of Plantronics, Inc. registered in the US and other countries. DECT is a trademark of ETSI.

Patents: US, 7,633,963; D643,834; D635,962; BR D170057796; CN ZL201030674530.7; ZL201030710900.8; EM 001788878-0001; 001792276-0003; IN 233102; KR 30-655804; TW D143596; D143955

202609-07 (06.14)