

MINIPATCH 10 CABINET & ACCESSORIES

Technical Information



A 10" compact wall mounting cabinet suitable for small office/home office (SOHO) applications or for where there is insufficient space or demand for a 19" cabinet based solution

Features:

- ◆ Lockable, reversible toughened glass door
- ◆ Adjustable 10" mounting rails
- ◆ Top and bottom cable entry with brush strip and blanking plate
- ◆ Rugged steel construction

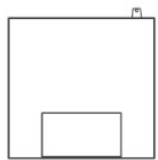

BOTTOM VIEW

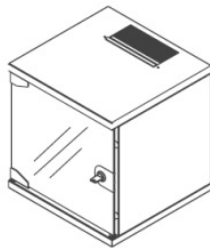

ISOMETRIC VIEW

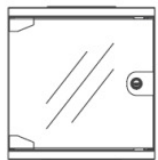

FRONT VIEW

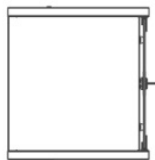

SIDE VIEW

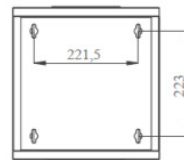

REAR VIEW

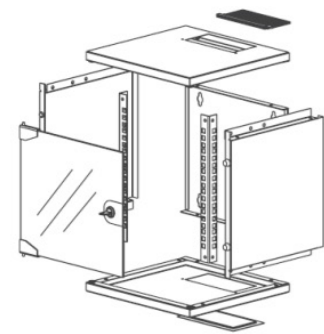

EXPLODED VIEW

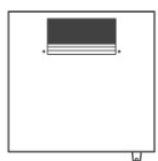

TOP VIEW

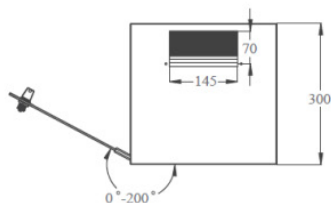

FRONT DOOR
OPENING ANGLE

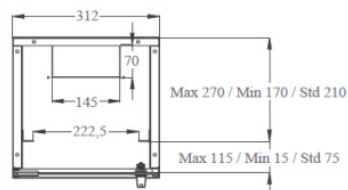

MAX/STD/MIN
EQUIPMENT
MOUNTING DISTANCE

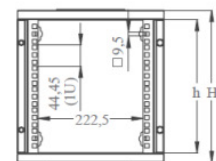

DIMENSIONS IN
WIDTH AND HEIGHT

MINIPATCH 10 CABINET & ACCESSORIES

Technical Information



Part Numbers

Item Code	Description
824460	9U 10" Wall Mounting Cabinet W=312mm D=300mm
805858	1U 10" Shelf D=150mm
805861	1U 10" Cable Management Panel with 3 rings
806043	1U 10" 3 way power Strip, with plug and on/off Switch
824459	1U 10" Blank Panel
824465	Minipatch 10 Patch Panel Unloaded 12Ports Shielded Keystone Black (H)1U x (W)10"
805860	Minipatch 10 Patch Panel Cat6 12Ports Unshielded Rear Punch Black (H)1U x (W)10"

